

6540-13

**Angle de pas
Schrittwinkel
Step angle** 1.8 °

**Diamètre
Durchmesser
Diameter** 42 x 42 mm

**Poids
Gewicht
Weight** 200 g

**Couple de retenue
Haltemoment
Holding torque** 110/90 mNm

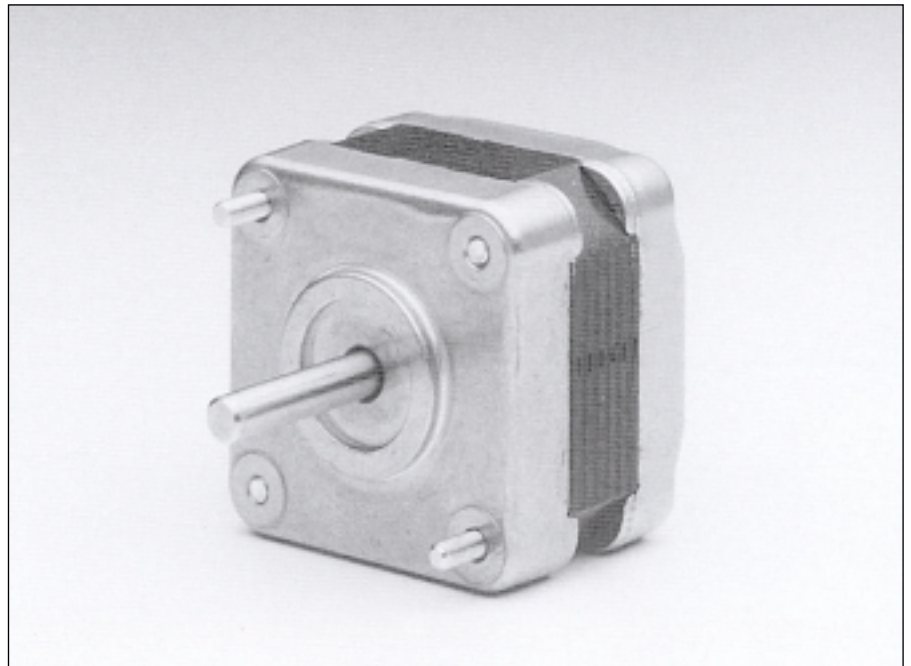

		Résistance de phase Phasenwiderstand Phase resistance Ω	Induct. de phase Phaseninduktivität Phase inductance mH	Courant de phase Phasenstrom Phase current A	Couple de retenue Haltemoment Holding torque mNm	Puissance nominale Nennleistung Nominal power W	
bipolar	6540-13-2-2	2	2	1.12	110	5	
	6540-13-2-9	9	9.5	0.52	110	5	
	6540-13-2-36	36	30	0.26	110	5	
unipolar	6540-13-4-2	2	1.1	1.12	90	5	
	6540-13-4-9	9	4.5	0.52	90	5	
	6540-13-4-36	36	17	0.26	90	5	

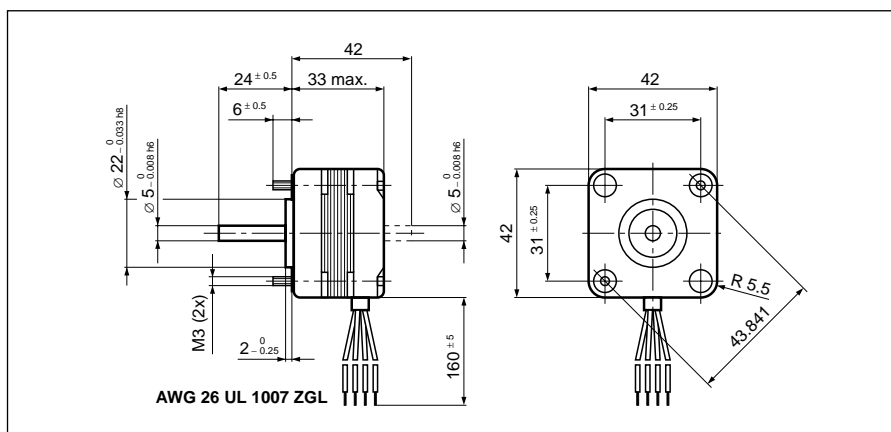

Pas/ Schritte/U Steps/rev	200
Précision/pas Schrittgenauigkeit Step accuracy	± 5 %
Inertie du rotor Rotorträgheitsmoment Rotor inertia	19 gcm²
Classe d'isolation Isolationsklasse Insulation class	B 130 °C
Protection Schutzart Protection	DIN 40050 IP 30
Tension d'essai Prüfspannung Test voltage	500 VAC
Couple résiduel Restmoment Detent torque	11 mNm

Caractéristiques dynamiques
Dynamische Daten
Dynamic characteristics

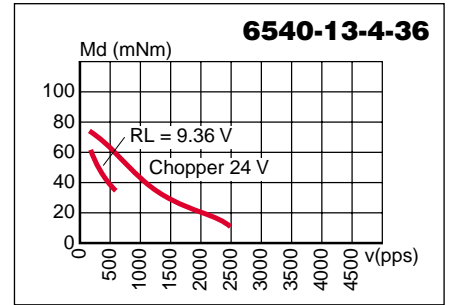
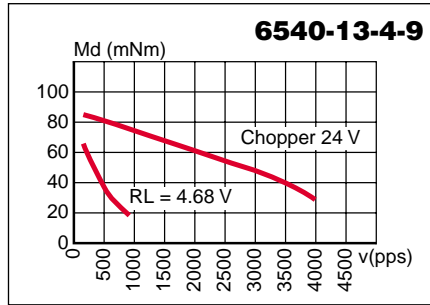
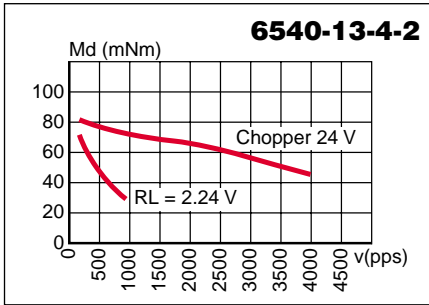
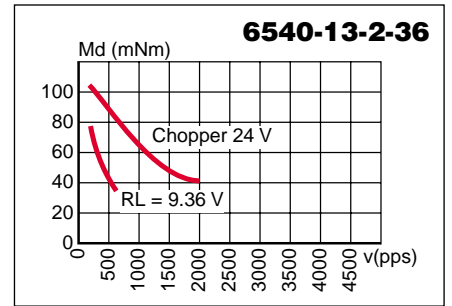
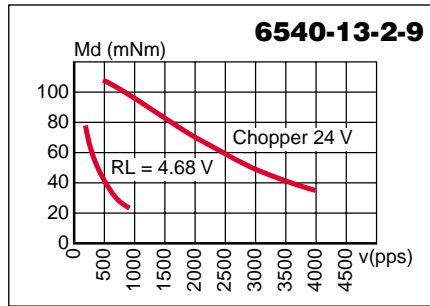
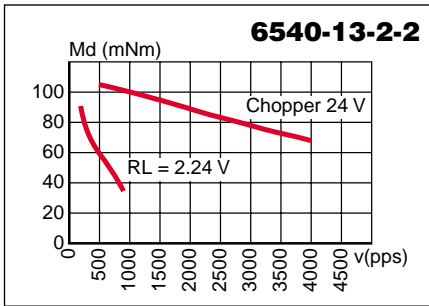

Caractéristiques statiques
Statische Daten
Static characteristics

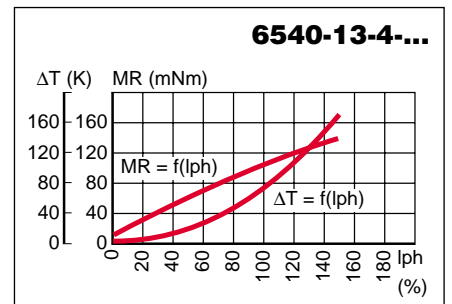
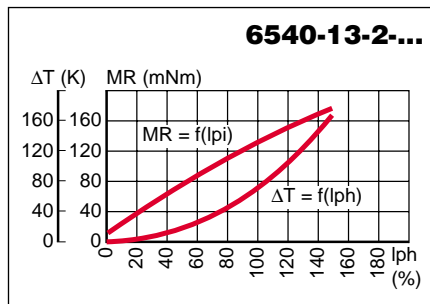

Possibilités d'exécutions adaptées sur demande.
 Auf Wunsch werden kundenspezifische Anforderungen berücksichtigt.
 Special requirements can be made to customer specification.

ACP&D Limited.
 Unit 9A,
 Charlestown Industrial Estate,
 Robinson Street,
 Ashton-under-Lyne,
 Lancashire, OL6 8NS.

Tel: +44 (0)161 343 1884
 Fax: +44 (0)161 339 0650
 e-mail: sales@acpd.co.uk
 Websites: www.acpd.com &
 www.acpd.co.uk

